



DECRYPTA

ALARM RECEIVER



v001211

Operating guide for Alarm Receiver DECRYPTA

Contents

Alarm Receiver DECRYPTA.....	2
Physical characteristics of DECRYPTA.....	2
Size.....	2
Buffer memory.....	2
Printer port.....	2
Phone jack.....	2
Power connector.....	2
Buzzer Alert/Warning.....	2
CMOS Lithium battery.....	2
Software tool COMIRQ.....	2
Installing DECRYPTA receiver.....	3
Configuring DECRYPTA receiver.....	3
Physical characteristics of DECRYPTA.....	3
Setting up DECRYPTA - Firmware Version 5.1.5+.....	4
Transmission rate.....	6
Formats and characters transmitted.....	12
Receiving.....	12
Listen-in, Two way voice.....	12
Transmission to computer and printer in DECRYPTA Native mode.....	12
Transmission to computer and printer in ADEMCO 685 / Surgard emulation mode.....	14
Messages from DECRYPTA to DECRYPTA printer port.....	14
Warranty.....	14
Legal compliance and Warning.....	14
United States Regulation FCC Warning.....	14
EC Declaration of Conformity.....	16
EN41003 Warning Application Note 48, Issue 5.....	16
Technical data sheet for DECRYPTA.....	18
Description.....	18
Features.....	18
Specifications.....	18

Operating guide for Alarm Receiver **DECRYPTA**

Alarm Receiver DECRYPTA

The twin line alarm receiver card DECRYPTA for PC and PC compatible computers is a MCDI product. It carries a five year limited warranty.

Physical characteristics of DECRYPTA

SizeSizeSize

Receiver has all out dimensions:
15" (L) x 5.5" (W) x 2"(H)
38 cm (L) x 14 cm (W) x 5 cm (H)

Housing: Rugged aluminum chassis.
Baked black enamel finish or nickel plating finish

Buffer memory

Buffer holds up to 800 events in Native mode, 1000 in Ademco emulation Mode. Buffer is used when computer is absent.

Unit keeps printing during fail time if power is connected and maintained. When computer comes back on, buffer empties to the computer. If more than 800 events (1000 Ademco mode) are received in the buffer during fail time, DECRYPTA writes over the oldest event. Written records may be available on printer connected to parallel printer port.

Printer port

Connector port for IBM compatible parallel printer type DB25. One printer can be used for all DECRYPTA linked by cables MRDC2 or MRDC3, instead of one printer per DECRYPTA unit. Events are also displayed on last DECRYPTA for all units.

Phone jack

Double Phone connector type RJ11 on Rev 4 and Rev 5. Connect Green and Red only on each connector

Power connector

A twelve (**12**) volt power input connector is located at the back of DECRYPTA. A 3 foot wire is supplied. Connect red wire to positive side and black wire to negative side of power source

Alert/WarningBuzzer

On board buzzer is available for alert warning when Computer is absent.
Enable if setup parameter Check printer is set to Yes.
Is activated (start buzzing) by event to be printed on DECRYPTA printer port.
Stop buzzing by pressing twice (2) ON-LINE printer key. Refer to printer connected to DECRYPTA parallel printer port. Will resume buzzing if printer is left off-line.

CMOS Lithium battery

Receiver memory function support depends on CMOS battery. CMOS battery is located on receiver position BT1. Renata Model CR2430 or equivalent. Minimum life expectancy 7 years to 10 years. Shelf life: 4 months.

Software tool COMIRQ

COMIRQ is a DOS software program shipped with all receivers. It is used to check signals sent to PC by DECRYPTA. This tool is very useful to find free IRQ.

To check installation and find free IRQ, run COMIRQ followed by COM,IRQ parameters.

Example: COMIRQ 3,5 (Check if IRQ 5 is free for a DECRYPTA installed on COM3)

When COMIRQ is displayed, send a signal to DECRYPTA where same setup parameters have been given. Signal is displayed only if COM and IRQ are free. If no signal is displayed, change IRQ in COMIRQ and in DECRYPTA setup. Try again until signal is displayed indicating a free IRQ.

Press Space bar to display one signal at a time. Press A to empty receiver buffer and enable ACK.

Operating guide for Alarm Receiver **DECRYPTA**

Installing DECRYPTA receiver

Power the DECRYPTA from any 12 volt source. Connect DECRYPTA to a computer serial port using the supplied null modem cable.

It is recommended to connect a printer to the DECRYPTA parallel port. This printer insures a full hard copy backup of all signals received by DECRYPTA. If a printer is not connected, make sure supplied jumper is connected to printer port.

Configuring DECRYPTA receiver

DECRYPTA is configured using Setup software INITPLUS or internal configuration menus. Configuration in French, German, Spanish and Portuguese is handled only by internal configuration menus.

DECRYPTA can be configured two ways:

1. Using DECRYPTA display and Menus. See P 8 to 11 of this document
2. Using INTIPLUS setup program. Connect DECRYPTA to PC. See Section above on How to install DECRYPTA

Physical characteristics of DECRYPTA

FRONT PANEL DESCRIPTION

POWER

Green LED
Lights when DECRYPTA is on.

LINE 1 +2

Red LED
Lights when a transmission occurs
Blinks when signal is absent

COMPUTER

Yellow LED
Lights when a transmission occurs
Blinks when computer is absent

PRINTER

Yellow LED
Lights when printing occurs

REAR PANEL DESCRIPTION

12V:

Power input 12 V DC 6W

SERIAL (DB25 male connector)

Data transfer to computer in Surgard emulation
Serial port: 1200 Baud, 8 bit, 1 stop bit
Pin 2 = transmit Pin 3= receive
Pin 7 = ground Cable type=null modem

PRINTER (DB25 female connector)

Printer parallel port

REMOTE

- For optional chaining of DECRYPTA units.
- Displays incoming signals on last DECRYPTA in row

LINE 1, LINE 2

Incoming phone lines

Operating guide for Alarm Receiver DECRYPTA

Setting up DECRYPTA Firmware -- Version 5.1.5+

Firmware version 5.1.5+ and setup program INITPLUS added features:

- . New setup display allows easier selection of software interface emulation formats:
Ademco 685 mode — Surgard mode — Native mode
- . Receiver handshake heading pattern is now selectable

Setup program **INITPLUS** (v1.9) displays selection pattern seen below:

Addresses	DECRYPTA PARAMETERS — MCDI INC. — +(514) 481-1067			
	Cold Reset: Ctl R			
03F8	Address	03F8		
02F8				
03E8	IRQ (Not applicable ot DECRYPTA)	5	Wait After Off Hook	No
02E8	Receiver number	1	2 Rings(Not in use; set to 1 ring)	No
0338	Line 1 Number	1	Caller ID To PC	No
0318	Line 2 Number	2	Caller Id To Printer	No
0308	Heartbeat	No	Caller ID ALL	No
02A8	Sescoa SS instead of 4x2 SUM	No	Date / Time	Yes
0298	3x2 Instead 4x1	No	Send Year	No
0288	Clear Zero	No	ACK Delay	1
0268	Compress Extended	No	SA-TLR/DECRYPTA	Yes
0258	Listen-In (Empty or 1..F)		SurGard Mode	No
0248	Printer / Buzzer	No		
0238				
0228	Start handshake with	1	1= 1400hz / VFSK	
0218			2= SIA / CFSK	
			3= DUAL 1400hz / 2300hz	
			4= 2300hz	
			5= Stratel	
			6= Telim	
			7= Robofon	
<CR> Edit		<ESC> Exit — <F1> Restore default — <F2> Read Config File		

Setup program display description and commands

Address section

Address part of display shows address fields for all DECRYPTA and TLR+/SA-TLR+ receivers installed with PC.

Move cursor to desired DECRYPTA using UP/DN arrows.

Press <Enter> to move to Parameter section on right part of display.

Parameters displayed on the right are actual operating parameters.

Press F1 to restore Factory defined parameters. Press F2 to restore saved parameters.

Press <ESC> to Exit setup program INITPLUS.

Before accepting Exit command, INITPLUS request authorization to save new parameters.

When exiting from INITPLUS time on ALL DECRYPTA/TLR+/SA-TLR+ will be reset to PC time.

Operating guide for Alarm Receiver DECRYPTA

Parameter section to the right of Address section

DECRYPTA address selected when entering this section is shown in heading above columns of parameters.

Move cursor to desired parameter using UP/DN arrow. Key in each new parameter .

After all changes have been entered press <ESC> to go back to Address Section.

ONLY in Address Section can changes be saved and sent to receiver.

Parameter definition

Emulation mode easy setting information:

MCDI Mode	Default setting
Ademco 685 Mode	Default setting + Date / Time = NO
Surgard Mode	Surgard = YES

OPTIONS:

Address IRQ	Memory address for DECRYPTA port as configured by connexion to com port. 3, 4, 5(default), 9, 10, 11, 12, 15	DECRYPTA requires no IRQ setting.
Receiver	Number sent to computer and printer 0 to F (default = 1)	
Line 1	Number sent to computer and printer 0 to F (default = 1)	
Line 2	Number sent to computer and printer 0 to F (default = 2)	
Heartbeat	Yes = enable	No = disable (default)
	DECRYPTA sends Heartbeat signals to computer every 30 seconds only in Native mode and Surgard mode.	
Sescoa SS	Yes = enable	No = disable (default)
	Conflict with Pulse 4X2 Checksum format	
3x2 Instead 4x1	Yes = enable	No = disable (default)
	Conflict with 4X1 in Compressed Expanded DO NOT select with Compressed Expanded = YES	
Clear Zero	Yes = Zero removed in 3x1 and 4x1	No = zero present (default)
	Tells DECRYPTA receiver <u>not to insert</u> a zero in front of the account number and in front of the alarm code, for incoming 3 x 1 and 4 x 1.	
	Example:	3 x 1 Extended compressed in 3 x 2 standard 123 4 444 5 After compression: 123 45
	Example:	3 x 1 Standard 3 x 1 123 1
	Example:	4 x 1 Standard 4 x 1 1234 1
	Example:	3 x 1 and 4 x 1 <u>without</u> the CLEAR ZERO option: 0123 01 for 3 x 1 1234 01 for 4 x 1
Compressed/ Extended	Yes = Compressed extended 3x1 or 4x1	(No = default)
	Example:	3 x 1 Extended compressed in 4 x 2 standard 123 4 444 5 After compression: 0123 45
	Example:	4 x 1 Extended compressed in 4 x 2 standard 1234 5 5555 6 After compression: 1234 56
Listen-In	Empty or 1 .. F	

Operating guide for Alarm Receiver DECRYPTA

(3x1,4x2)	Define code to trigger Listen-In mode in 3x1 or 4x2 formats	
Printer/Buzzer	Yes = Check printer on DECRYPTA port	No= Do not check for printer (default)
	By default DECRYPTA <u>does not verify printer status on parallel port</u> but sends data to be printed as if a printer was connected to this port.	
	(Yes) option tells the DECRYPTA receiver to verify and report on the status of the printer connected to the DECRYPTA parallel port. The status verification applies to the DECRYPTA (lowest COM) in the computer if more than one MCDI receiver is installed. A connector is needed to daisy chain multiple DECRYPTA receivers to send all output to one printer only.	
	When Check printer option is enabled (Yes) and the computer is absent, each event being sent to printer triggers a warning buzzer. This warning sound may be stopped by clicking twice the ON-LINE printer key. Buzzing resumes if printer is left Off-line.	
	Do not set the "Yes" parameter if no printer is installed. Multiple error messages could be generated by taking this action.	
Wait after O/H	Delay to start Handshake after Off Hook. No = normal, Yes=5 seconds	
2 Rings	Setting not in use. DECRYPTA set to 1 ring. Setting not Caller ID dependent	
Caller ID PC	No = Do not send telephone ID data to PC Yes = Send telephone ID data to PC	
Caller ID PRN	No = Do not send telephone ID data to DECRYPTA printer Yes = Send telephone ID data to DECRYPTA printer	
Caller ID ALL	No = Do not send telephone ID data except when bad transmission occurs Yes = Send telephone ID data to PC and DECRYPTA printer unless PRN and PC select otherwise	
Date / Time	Yes = enable(Default)	No = disable
Send year	Yes = Date including the year	No = Date with no year (default)
	Yes, tells DECRYPTA to add the Year in date format: HH:mm __ MM/DD[YY] ...	
	No, by default, tells DECRYPTA to use date and time format: MM/DD.	
SA-TLR+	Yes = enable (SA/TLR+/DECRYPTA)	No = disable (Default=DECRYPTA)
Surgard Mode	Yes = enable	No = disable (Default)
ACK delay	Wait time in seconds for ACK reception before resend. (Surgard/Native mode only)	
Start handshake with	1	1400hz / VFSK
	2	SIA / CFSK
	3	DUAL 1400hz / 2300hz
	4	2300hz
	5	STRATEL
	6	TELIM
	7	ROBOFON
	Default sequence is as above. Option is to change first element with the one selected. Extreme care must be exercised when changing Handshake sequence. It is a well known fact that many dialers do not respond well to all startup sequences.	

Transmission rate

1200 bps, no parity, 8 bits, 1 stop bit

Operating guide for Alarm Receiver DECRYPTA

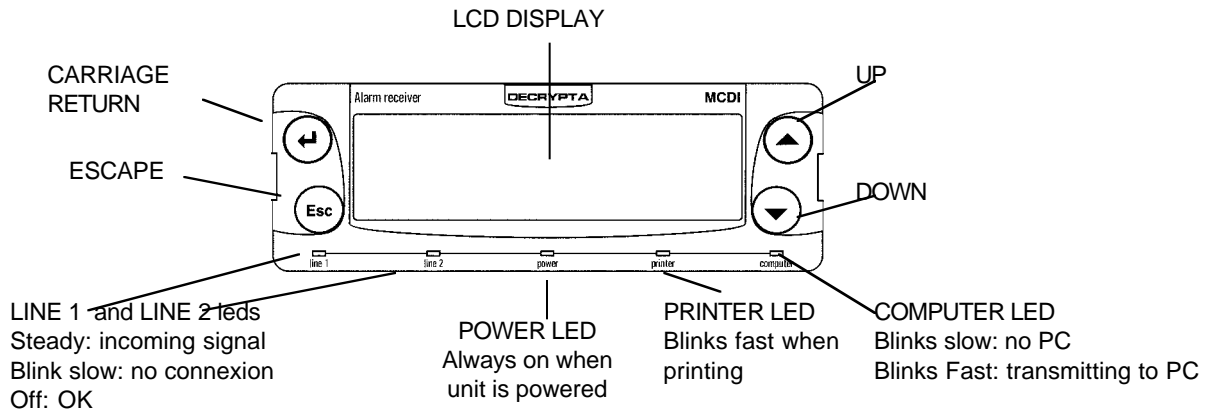
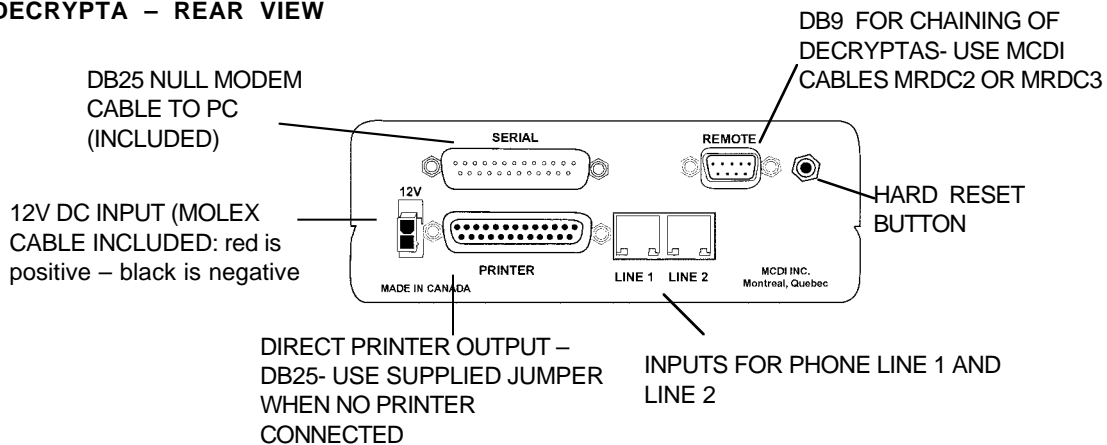
DESCRIPTION OF DECRYPTA DISPLAY**DECRYPTA – FRONT VIEW****DECRYPTA – REAR VIEW****CARE OF LCD UNIT:**

To clean, always use a slightly damp cloth; never use abrasives or solvents. Avoid pressure and shock on LCD area: damage may results.

CARE OF DECRYPTA UNIT:

To clean, always use a slightly damp cloth; never use abrasives or solvents. Avoid pressure, shock, vibration, moisture and excessive humidity: damage may results. Do not expose to direct sunlight.

Operating condition: 4°C to 40°C.

Storage condition: -15°C to 65°C

Always use a 12V DC power supply , 6W, with supplied cable.

Operating guide for Alarm Receiver DECRYPTA

DESCRIPTIONS OF INTERNAL MENUS

Start up menu

On power up

```

DECRIPTA
Alarm Receiver
Version 1.0.0.
MCDI Inc.
    
```

Configuration menu

To enter configuration, press

and simultaneously

```

          Congifuration Mode
          ::::::::::::::::::::::::::::
    
```

At any point during configuration

Pressing will save configuration

```

          Saving Configuration
    
```

Choice of language

to select from english, spanish (español), french (français) portuguese (português) or german (deutsch)

to choose language and continue to next menu in selected language

```

          -DECRYPTA-
Choice                                     Option
-----
Language                                  English
    
```

Assigning a receiver number

to select from 1 to 9

to choose and continue to next menu

```

          -DECRYPTA-
Choice                                     Option
-----
Receiver number                            01
    
```

Assigning a number to line 1

to select from 1 to 9

to choose and continue to next menu

```

          -DECRYPTA-
Choice                                     Option
-----
Line 1 number                              01
    
```

Assigning a number to line 2

to select from 1 to 9

to choose and continue to next menu

```

          -DECRYPTA-
Choice                                     Option
-----
Line 2 number                              02
    
```

Enabling heartbeat

to select from yes or no



to choose and continue to next menu

```

          -DECRYPTA-
Choice                                     Option
-----
Heartbeat                                  Yes
    
```

Operating guide for Alarm Receiver DECRYPTA



Enabling Sescoa SS format

 to select from yes or no
 to choose and continue to next menu

```

-DECRYPTA-
Choice                               Option
-----
Sescoa SS                            Yes
  
```



Enabling 3x2 instead of 4x1

 to select from yes or no
 to choose and continue to next menu

```

-DECRYPTA-
Choice                               Option
-----
3x2 inst'd 4x1                        Yes
  
```



Enabling clear zero

 to select from yes or no
 to choose and continue to next menu

```

-DECRYPTA-
Choice                               Option
-----
Clear Zero                             Yes
  
```



Enabling Extended/compressed

 to select from yes or no
 to choose and continue to next menu

```

-DECRYPTA-
Choice                               Option
-----
Extended                               Yes
  
```



Choosing listen-in code

 to select from 1 to 9, A to F. "0" = empty
 to choose and continue to next menu

```

-DECRYPTA-
Choice                               Option
-----
Listen-In code                         E
  
```



Check printer/buzzer mode



 to select from yes or no
 to choose and continue to next menu

```

-DECRYPTA-
Choice                               Option
-----
Check printer                          Yes
  
```

Handshake order configuration





 to select from 1 to 7
 1=1400hx/VFSK 2=SIA/CFSK
 3=Dual 1400Hz/2300Hz 4=2300hz
 5=Stratel
 6=Telim (on Telim models only)
 7=Robofon (on Robofon models only)

 to choose and continue to next menu

```

-DECRYPTA-
Choice                               Option
-----
Start H'SHake                          1
  
```

Wait after off hook option





 to select from no or yes (4.5 seconds delay)
 to choose and continue to next menu

```

-DECRYPTA-
Choice                               Option
-----
Wait after O/H                          Yes
  
```

Operating guide for Alarm Receiver DECRYPTA



Enabling CALLER ID to PC

-   to select from yes or no
 to choose and continue to next menu

```

-DECRYPTA-
Choice                               Option
-----
Caller ID to PC                       Yes
  
```



Enabling CALLER ID to printer

-   to select from yes or no
 to choose and continue to next menu

```

-DECRYPTA-
Choice                               Option
-----
Caller ID printer                      Yes
  
```



Enabling CALLER ID to pc and printer

-   to select from yes or no
 to choose and continue to next menu

```

-DECRYPTA-
Choice                               Option
-----
Caller ID All                          Yes
  
```



Sending date and time option

-   to select from yes or no
 to choose and continue to next menu

```

-DECRYPTA-
Choice                               Option
-----
Date/time                              Yes
  
```



Delay time for acknowledge to pannel

-   to select delay in seconds from 1 to 5
 to choose and continue to next menu

```

-DECRYPTA-
Choice                               Option
-----
ACK delay                              2
  
```



Check printer/buzzer mode

-   to select from yes or no
 to choose and continue to next menu

```

-DECRYPTA-
Choice                               Option
-----
Check printer                          Yes
  
```



Output in Sur-Gard mode

-   to select from yes or no
 to choose and continue to next menu

```

-DECRYPTA-
Choice                               Option
-----
Sur-Gard mode                          Yes
  
```



Setting Time: hour

-   to select from 00 to 23
 to choose and continue to next menu

```

-DECRYPTA-
Choice                               Option
-----
Time: hour                             00
  
```

Setting Time: minutes

-   to select from 00 to 59
 to choose and continue to next menu

```

-DECRYPTA-
Choice                               Option
-----
Time: minutes                           22
  
```

Operating guide for Alarm Receiver DECRYPTA

Setting Date: month

to select from 01 to 12
 to choose and continue to next menu

```

-DECRYPTA-
Choice                               Option
-----
Date: Month                           02
    
```

Setting Date: day

to select from 01 to 31
 to choose and continue to next menu

```

-DECRYPTA-
Choice                               Option
-----
Date: day                              24
    
```

Setting Date: year

to select from 00 to 99
 to choose and return to begin of configuration mode

```

-DECRYPTA-
Choice                               Option
-----
Date: Year                             00
    
```

Will save all configuration. Message saving configuration will appear.

Saving Configuration

press simultanously will reset DECRYPTA to factory default

DECRYPTA reseted

```

::: 00/12/07 :::
00:12:04
    
```

IDLE MODE

When not in configuration nor receiving signals, Decrypta displays date on first line and time on second line

TYPICAL DISPLAYS-INCOMING SIGNALS

4X2, CALLER ID NATIVE FORMAT

LINE 1: TIME AND DATE	15:30:27__12/07/00
LINE 2: RECEIVER AND LINE NUMBER; SIGNAL FROM PANNEL	12 6161 F6 {4811067}
LINE 3: CALLER ID INFORMATION	

CONTACT ID, CALLER ID, NATIVE FORMAT

LINE 1: TIME AND DATE	15:30:38__12/07/00
LINE 2: RECEIVER AND LINE NUMBER; SIGNAL FROM PANNEL	12 6262 E121 01 000
LINE 3: CALLER ID INFORMATION	{4811067}

SIA, CALLER ID, NATIVE FORMAT

LINE 1: TIME AND DATE	15:30:47__12/07/00
LINE 2: RECEIVER AND LINE NUMBER; SIGNAL FROM PANNEL	12 [#6363INHHA000]
LINE 3: CALLER ID INFORMATION	{4811067}

Operating guide for Alarm Receiver **DECRYPTA**

Formats and characters transmitted

Receiving

Formats	MCDI Acron Ademco L/S expanded Ademco Old Franklin Fast Radionics Expanded Sescoa SS CFSK III SurGard	DTMF Ademco Contact ID Ademco Fast / High Speed DCI Napco Scantronic SIA I - II - ~III Varitech VFSK Robofon	FSK Ademco L/S Standard Ademco Express FBI Super Fast Radionics Standard Sescoa standard Silent Knight Slow/Fast Stratel Telim
Pulse	10,20,40 bps 3x1 - 4x1 - 4x2 10,20,40 bps 4x2 10,20,40 bps 3x1 - 4x1 Extended Frequencies Handshake and kissoff:		Dual Round Checksum Dual Round 1800 Hz / 1900 Hz 1400hz / 2300hz
DTMF	10 char/sec.		
FSK	110 bauds or 300 bauds (SIA, CFSK, VFSK)		Bell 103

Listen-in, Two way voice

Listen-in function

Some alarm panels offer the option for the Central station operator to listen for sound in the premises where the alarm signal originates.

Alarm panels supporting "Listen-in" keep the telephone line open after having sent a signal, to allow sound monitoring. The telephone line will be closed by the Central station subject to operator action or receiver setup.

Listen-in criteria

Receiver DECRYPTA is triggered into "Listen-in" mode for incoming events according to panel setup for specific formats.

SIA and Contact ID formats have specific codes for Listen-in. See Panel setup.

DTMF formats use the AEx signal where x can be 0 to F at the Installer's choice.

3x1 and 4x2 formats have no standard codes for Listen-in. DECRYPTA allows self selection of Listen-in codes at Setup time.

Receiver action upon reception of "Listen-in" trigger

Upon reception of event in the Listen-in category, DECRYPTA receiver maintains the telephone line open for a period of up to 180 seconds or less then 180 seconds upon reception of any telephone tone from the keypad.

Operator control for "Listen-in"

Operator must be warned by Monitoring software of account "listen-in" capability. Operator has a maximum of 180 seconds from time of alarm reception to telephone pickup. Failure to pickup telephone in this delays will cause line hang-up by DECRYPTA receiver.

Once the line is seized by Central station local telephone, the hang-up action of DECRYPTA will have no effect.

To close communication with alarm signal site in the first 180 seconds when DECRYPTA is in action, operator must press any key on the telephone keypad before hanging up. The DECRYPTA will hang up telephone line before 180 seconds only upon reception of a tone from telephone keypad.

To close communication with alarm signal site after 180 seconds of event reception, simply hang-up the telephone. This is because the DECRYPTA is not in function anymore, its delay having expired.

Transmission to computer and printer in DECRYPTA Native mode

Pulse, DTMF, FSK

FORMAT 3x1, 4x1

```
HH:mm_ MM/DD[YY] _ _ RL_CCCC_ØA<CR>
HH:mm_ MM/DD[YY] _ _ RL_CCCC_A<CR>
HH:mm_ MM/DD[YY] _ _ RL_CCC_A<CR>
HH:mm_ MM/DD[YY] _ _ RL_ØCCC_AZ<CR>
```

```
Default
Option 4x1 set by INITLR
Option 3x1 set by INITLR
Option 3x1 extended compressed 4x2
```

Operating guide for Alarm Receiver DECRYPTA

HH:mm_ MM/DD[/YY] _ _RL_CCCC_AZ<CR>	Option 4x1 extended compressed 4x2 Option zero removed 3x1,4x1, extended	
FORMAT 4x2		
HH:mm_ MM/DD[/YY] _ _RL_CCCC_AZ<CR>		
FORMAT 4x3 (SESCOA SS)		
HH:mm_ MM/DD[/YY] _ _RL_CCCC_AZZ[Z]<CR>		
FORMAT 4x3 (SUR GARD)		
HH:mm_ MM/DD[/YY] _ _RL_CCCC_AZZ<CR>		
FORMAT ADEMCO HIGH SPEED		
HH:mm_ MM/DD[/YY] _ _RL_CCCC_AAAA_AAAA_A<CR>		
FORMAT ACRON		
HH:mm_ MM/DD[/YY] _ _RL_CCCC_AAAAAAAAA<CR>		
HH:mm_ MM/DD[/YY] _ _RL_CCC_AAAAAAAAA<CR>		
FORMAT FBI SUPER FAST		
HH:mm_ MM/DD[/YY] _ _RL_CCCC_EZZ<CR>		
FORMAT CONTACT ID		
HH:mm_ MM/DD[/YY] _ _RL_CCCC_18_TAAA_GG_ZZZ<CR>		
FORMAT MODEM SIA		
HH:mm_ MM/DD[/YY] _ _RL_ [#CCCCC EAAZZZ/AAZZZ/AAZZZ]<CR>	Native mode	
<LF>RL_ [#CCCCC EAAZZZ/AAZZZ/AAZZZ]<CR>	Ademco685 Emulation	
FORMAT MODEM CFSK / VFSK (same as 4x2)		
HH:mm_ MM/DD[/YY] _ _RL_CCCC_AZ<CR>		
CALLER ID		
Phone signal added to event code. Examples		
HH:mm_ MM/DD[/YY] _ _RL_CCCC_AZ{t..t}<CR>	Added to 4x2	
HH:mm_ MM/DD[/YY] _ _RL_CCCC_18_TAAA_GG_ZZZ {t..t}<CR>	Added to Contact ID	
HH:mm_ MM/DD[/YY] _ _RL_ [#CCCCC EAAZZZ/AAZZZ/AAZZZ]{t..t}<CR>	Added to SIA	
Heartbeat		
@<CR>	Signal sent to the computer every 30 seconds if option is enabled	
Code definitions		
HH	: Hour	
:	: Character ":"	
mm	: Minute	
DD	: Day	
_	: 1 space	
_ _	: 2 spaces	
MM	: Month	
[YY]	: Year [Present/Absent]	Receiver Option)
/	: Character "/"	
R	: Receiver number	(Receiver Option)
L	: Line number	(Receiver Option)
C	: Account number	
A	: Event code or modifier	
E	: Zone type	FBI super Fast
Z	: Zone	
G	: Group (Partition)	
T	: Type(E or R)	(Contact ID)
Ø	: Zero	

Operating guide for Alarm Receiver **DECRYPTA**

<CR>	:	EOS	(Carriage Return)
<ACK>	:	Data retransmits to computer every 2 second	until ACK is received by DECRYPTA (ACK=06H or \$06).
@	:	Heartbeat signal	Receiver Option)
t..t	:	Telephone number from Caller ID	
[:	Beginning data delimiter (SIA)	
]	:	Ending data delimiter (SIA)	
	:	Field separator (SIA)	
#	:	Account ID block code (SIA)	
E	:	Function block code (SIA)	
/	:	Data code packet separator (SIA)	
<LF>	:	Line Feed	

DECRYPTA Error and Warning messages sent to Printer port and PC:

	<u>HH:MM</u>	<u>MM/DD[YY]</u>	<u>RL</u>	<u>Account</u>	<u>XY</u>	
Printer message	Time	Date	Receiver	0000	01	Printer error
	Time	Date	Receiver	0000	02	Printer reset
Telephone line monitoring	Time	Date	Receiver	0000	03	Error Line 1
	Time	Date	Receiver	0000	04	Reset Line 1
Telephone line monitoring	Time	Date	Receiver	0000	05	Error Line2
	Time	Date	Receiver	0000	06	Reset Line2
External battery backup	Time	Date	Receiver	0000	07	Low external battery
	Time	Date	Receiver	0000	08	Normal external battery
CMOS RAM battery	Time	Date	Receiver	0000	09	Low CMOS battery
	Time	Date	Receiver	0000	0B	Normal CMOS battery
Transmission message	Time	Date	Receiver	0000	00	Bad transmission
	Time	Date	Receiver	[#0000]A BAD TRANSMISSION]		Format SIA
No Transmission	Time	Date	Receiver	0000	F1	No signal received Line 1
	Time	Date	Receiver	0000	F2	No signal received Line 2

Transmission to computer and printer in ADEMCO 685 / Surgard emulation mode

User Manual : for information on transmission See ADEMCO 685 standards
 User Manual : for information on transmission See Surgard MRL2 documentation
 Surgard emulation applies to Dial up Alarm signals and Telephone ID

Messages from DECRYPTA to DECRYPTA printer port

When computer ceases to answer "Computer absent" is sent to DECRYPTA parallel port
 When computer answers "Computer restore" is sent to DECRYPTA parallel port

Warranty

The Electronic products of MCDI Inc. are under a five year limited warranty. Material is repaired or exchanged, free of charge, when returned to MCDI service points, post paid. Abused or misused equipment is not covered by this warranty. Power surge damages are not covered by warranty.

Legal compliance and Warning

United States Regulation FCC Warning

Radio/TV interference

This device is not equipped with dialing equipment.

Telephones equipped with electronic dialing keys generate and use radio frequency energy, and if not installed and used properly and in strict accordance with the manufacturer's instructions, may cause interference to radio and television reception.

NOTE: This device has been tested and found to comply with Part 15 if the FCC rules. Operation is subject to the following two conditions:

1. This device may not cause harmful interference and

Operating guide for Alarm Receiver **DECRYPTA**

2. This device must accept any interference received, including interference that may cause undesirable operation.

If your device causes interference, one of the following measure may correct the problem:

- . Reorient or relocate the receiving TV or radio antenna, when this may be done safely.
- . To the extent possible, move the device and the radio or television farther away from each other, or connect the computer with the device and the radio or television to outlets on separate circuits.
- . Consult the dealer or an experienced radio/television technician for additional suggestions.

NOTE: FCC registration does not constitute an expressed or implied guarantee of performance.

Right of the Telephone Company

If this device causes harm to the telephone network, the telephone company may stop your service temporarily or ask you to remove your equipment until the problem is resolved. If possible, they will notify you in advance. If advance notice is not practical, you will be notified as soon as possible and be given the opportunity to correct the situation. You will also be informed of your right to file a complaint with the FCC.

Your telephone company may make changes in its facilities, equipment, operations or procedures that could affect the proper function of this device. If they do, you will be notified in advance to give you an opportunity to maintain uninterrupted telephone service.

Federal communication commission (FCC) Notice

FCC Registration Number: This device complies with Part 68, Rules and Regulations, of the FCC for direct connection to the Public Switched Telephone Network (the FCC registration number and REN number appear on a sticker). If requested, this information must be provided to the telephone company.

Your connection to the telephone line must comply with these FCC rules:

- . Use only an FCC standard RJ11W/RJ14W or RJ11C/RJ14C network interface jack and FCC compliant line cord and plug to connect to the telephone line. (To connect the device press the small plastic tab on the plug at the end of the telephone's line cord. Insert into a jack until it clicks. To disconnect, press the tab and pull out.)
- . If a network interface jack is not already installed in your location, you can order one from your telephone company. Order RJ11W/RJ14W for wall mounted telephones or RJ11C/RJ14C for desk/table use. In some states, customers are permitted to install their own jacks.
- . This device may not be connected to a party line or coin telephone line. Connection to Party Line Service is subject to state tariffs (contact the state public utility commission, public service commission or corporation commission for information).
- . It is no longer necessary to notify the telephone company of your device's Registration and REN number however, you must provide this information to the telephone company if they request it.
- . If trouble is experienced with this equipment, for repair or warranty information please contact:
 - Local dealer or
 - MCDI
 - 86 Claude-Champagne Avenue., Montreal, QC, Canada H2V 2X1
 - Telephone: +(514) 481-1067 Fax: +(514) 481-1487
- . If the equipment is causing harm to the telephone network, the telephone company may request that you disconnect it until the problem is resolved.
- . This device does not have any serviceable parts. Repair or exchange must be made by the manufacturer or its representatives.

Signaling method: This device does not dial out.

Ringer Equivalence Number: The FCC Registration label (on the device) includes a Ringer Equivalence Number (REN) which is used to determine the number of devices you may connect to your telephone line. A high total REN may prevent telephones from ringing in response to an incoming call and may make placing calls difficult. In most areas, a total REN of 5 should permit normal telephone operation. To determine the total REN allowed on your telephone line, consult your local telephone company.

Hearing aids This device does not convert the signal for human hearing.

Programming Emergency numbers: This device does not dial out.

Important safety instructions

When using the device, basic safety precautions should always be followed to reduce risk of fire, electrical shock and injury to persons including the following:

1. Read and understand all instructions.
2. Follow the warnings and instructions marked on the product.
3. This device is installed in a computer. This work should be done by a qualified computer technician.
4. Avoid using during electrical storm. There may be a remote risk of electrical shock from lightning.

Operating guide for Alarm Receiver **DECRYPTA**

5. CAUTION: Do not use sharp instruments during installation procedure to eliminate the possibility of accidental damage to the device, the computer or the cord.
6. Save these instructions.

Europe EC Declaration of Conformity EC Declaration of Conformity EC Declaration of Conformity

We:

MCDI Inc.
86 Claude-Champagne Avenue
Montreal, QC
Canada H2V 2X1

Declare under our sole legal responsibility that the following products conform to the protection requirements of council directive 89/336/EEC on the approximation of the laws of member states relating to electromagnetic compatibility, as amended by directive 93/68/EEC:

MCDI-DECRYPTA alarm receiver

The products to which this declaration relates are in conformity with the following relevant harmonised standards, the reference numbers of which have been published in the Official Journal of the European Communities:

EN50082-1:1992 --- EN55022 CLASS A --- EN 60555 PARTS 2 & 3 --- EN41003:1993 --- BAPT Note 48 revision 5
EN60950/IEC Ed 2 Amendment No1 1992, Amendment No2 1993, Amendment No3 1996

Signed this 7th day of January 1997

MCDI Inc.

Europe EN41003 Warning Application Note 48, Issue 5 EN41003 Warning Application Note 48, Issue 5 EN41003 Warning Application Note 48, Issue 5

- 1) The power required by the host and the total of all adapter cards installed within the host environment, together with any auxiliary apparatus, shall not exceed the power specification of the host apparatus.

The power requirements for the DECRYPTA receiver are:

From External Battery (standby) 12V 1A

- 2) It is essential that, when other option cards are introduced which use or generate a hazardous voltage, the minimum creepages and clearances specified in the table below are maintained. A hazardous voltage is one which exceeds 42.4V peak a.c. or 60V d.c. If you have any doubt, seek advice from a competent engineer before installing other adapters into the host equipment.

- 3) The equipment must be installed such that with the exception of the connections to the host, clearance and creepage distances shown in the table below are maintained between the card and any other assemblies which use or generate a voltage shown in the table below. The larger distance shown in brackets applies where the local environment within the host is subject to conductive pollution or dry non-conductive pollution which could become conductive due to condensation. Failure to maintain these minimum distances would invalidate the approval.

- 4) The analogue telecommunications interface is intended to be connected to telecommunication network voltage (TNV) circuits which may carry dangerous voltages. The telephone cord(s) must be disconnected from the telecommunications system until the card has been installed within a host which provides the necessary protection of the operator. If it is subsequently desired to open the host equipment for any reason, the telephone cord(s) must be disconnected prior to effecting access to any internal parts which may carry telecommunication network voltages.

Table:

Clearance (mm) X	Creepage (mm) Y	Voltage Used or Generated by Host or Other Cards
2.0	2.4 (3.8)	Up To 50 Vrms or Vdc
2.6	3.0 (4.8)	Up To 125 Vrms or Vdc
4.0	5.0 (8.0)	Up To 250 Vrms or Vdc
4.0	6.4 (10.0)	Up To 300 Vrms or Vdc
For a host or other expansion card fitted in the host, using or generating voltages greater than 300V (rms or dc), advice from a competent telecommunication safety engineer must be obtained before installation or relevant equipment		Above 300 Vrms or Vdc

Operating guide for Alarm Receiver DECRYPTA

Host:

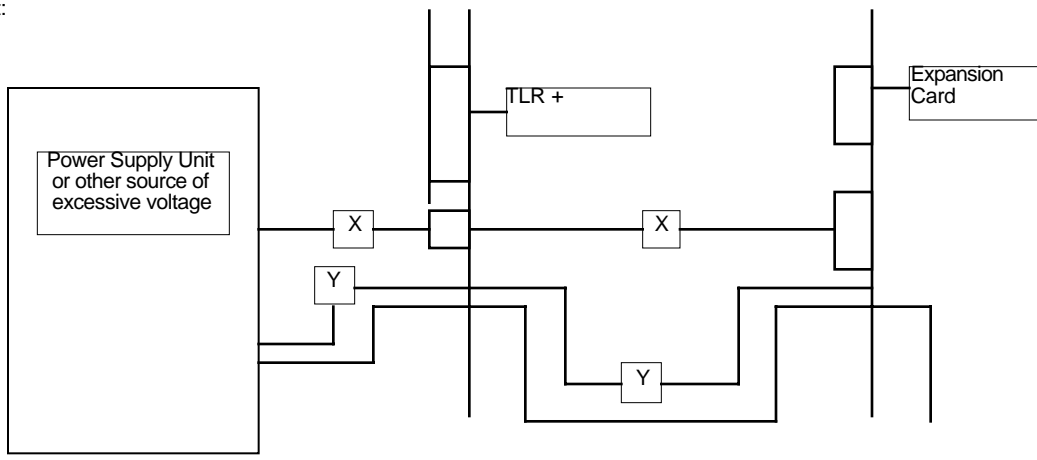

Operating guide for Alarm Receiver **DECRYPTA**

Technical data sheet for DECRYPTA

Description

DECRYPTA is the ideal receiver for mobile surveillance and field maintenance.

DECRYPTA has all features of TLR+ and SA-TLR+ receivers and now an integrated display. **DECRYPTA** is a compact high performance stand alone receiver you can bring in the field or use with all PCs and laptops.

DECRYPTA has two telephone line inputs. Imposes no limit on number of accounts per line and provides a DB25 parallel printer port for direct printer output.

With rugged construction, ease of operation and mobility, **DECRYPTA** adds many new and attractive features to the basic Monitoring Station.

Line circuitry FCC(USA), IC(Canada), CE-Security (Europe), CE-Telecom (Europe), ICT D800-428K (Germany), IBPT TC970587 (Belgium) certified .

Specifications

Communications:

DECRYPTA provides an 2 RJ11 type phone jacks for connection to one or two telephone lines.

Type	:	Pulse, DTMF, FSK
Reception Speed	:	10, 20, 40 pps DR / CS
Handshake and Kissoff	:	1400Hz / 2300Hz/2225Hz
Pulse Frequency//Telim	:	1800Hz / 1900H//1100Hz

Reception Formats supported:

Acron	Radionics 6500
Ademco:	Radionics extended
- Slow/Fast;	Sescoa Slow, Super Fast
- Contact ID;	Sescoa Standard
- Extended;	SIA
- Express;	Contact ID
- High Speed	- compressed & converted
CFSK,BFSK VFSK	Silent Knight Slow
MCDI-Take-a-look	SurGard
FBI Super Fast	Napco Point ID
3x1	3x1 extended
4x1	3x1 extended compressed 4x2
4x1 extended	4x1 extended compressed 4x2
4x2	Zero removed 3x1, 4x1, extended.
Optex's Varitech	C&K: Bell 103A2 or CCIT on option
For Germany and Scandinavia, as Pulse replacement:	
Telim	Robofon

Printer Output:

- Standard DB25 connector for Centronics Parallel Interface.
- Cables MRDC2 AND MRDC3 (option) allow one printer to serve all **DECRYPTA** receivers chained.

Event logging when PC is absent:

DECRYPTA stores up to 800 events (Native mode), or 1000 events (Ademco 685™ mode / SurGard™ mode). Events are stored as a sequential pile and displayed on screen.

Features

- Mobile without need of reconfiguration.
- Internal buffer 800 to 1000 events.
- CMOS Lithium battery for non volatile memory.
- Supports SIA, BFSK,CSFK, VFSK etc.
- Caller ID option
- Supports software retransmit function.
- Alert/Warning buzzer for operation without PC.
- Acknowledge function on front panel.
- Dead line detection and operation status on front panel.
- Printer status on front panel.
- Interface with wireless phone terminals around the world.
- Listen-in, Two way voice

Size and construction:

Size: 15" (L) x 5.5" (W) x 2"(H)
38 cm (L) x 14 cm (W) x 5 cm (H)

Housing: Rugged aluminum chassis.
Baked black enamel finish.
Nickel plated silver finish on special order

Monitoring Software:

DECRYPTA interfaces with Monitoring software in Native mode, Ademco 685™ emulation mode and SurGard™ emulation mode.

Compatible with most automation software on the market.

Configuration

- 1 parallel port DB25 for printer.
- 1 serial port for connection to computer.
- 1 port DB9 for linking DECRYPTAs
- 2 RJ11 telephone line jacks.
- 5 status LED on front panel.
- Configurable by PC (286 or up) or directly on front panel
- Configuration software included.
- Four sealed controls on front panel

Display

- Displays incoming signals or controls on 4 lines by 24 characters.
- Displays last 800 events
- Configuration and operation on front panel
- Alarm acknowledge key for easy operation.
- Configuration menus in English, French, German, Spanish or Portuguese